

The GENERAL RADIO EXPERIMENTER

VOL. 1 NO. 7

JANUARY, 1922

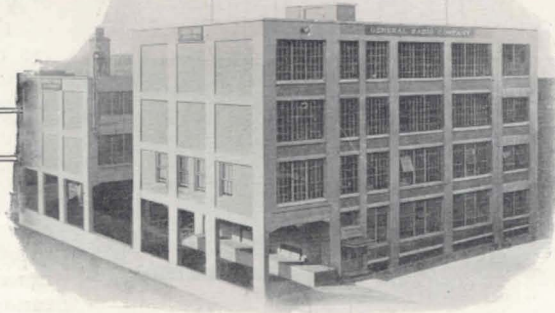

Design and Testing of Plate Supply Devices

By P. K. McELROY, Engineering Dept.

Part II—Testing

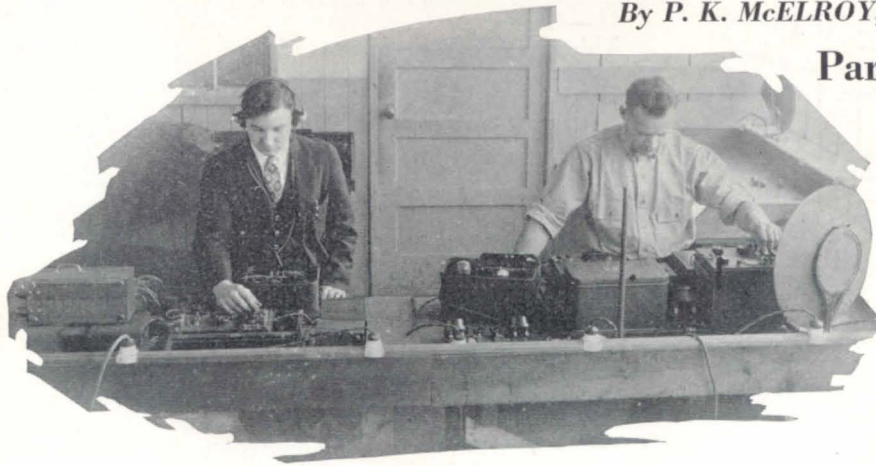

[Editor's Note: The following is the second of two articles on plate supply devices, the first of which appeared in the December number of the Experimenter. Although each article is complete in itself, this second one will be clearer if it is read after reading the first article, and with a copy of the first article at hand for reference.]

II. Testing

The first of these two articles, in last month's Experimenter, completed a discussion of the design features of power units. One of the figures used to illustrate that article is repeated for reference in this issue, as is also the diagram used in the article in that issue by Mr. Lamson on "Biasing the Power Amplifier Tube from a Plate Supply Unit." This latter diagram, Figure 3, will serve, in conjunction with Figure 2, to illustrate the circuits used in our power amplifiers, which supply, in addition to B voltages for the receiver, a power audio stage operated entirely

without batteries. Reference to Figures 2a and 3 will clarify the discussion of testing methods which is to follow. The only point not covered in those two drawings is the use of buffer condensers across the supply transformer secondaries in the conventional Raytheon rectifier circuit, but it is thought that this matter is sufficiently familiar to readers to permit its omission here.

During assembly in actual production and after the Units are completed, it is essential that very comprehensive tests be applied. Naturally, the finished units must be known to be correct in all respects before being shipped out. In addition, it is found to be the best procedure to test quite completely the units at each stage of the assembly, in order to catch defects before the wax has been poured over the various parts and correction made thereby more difficult. Figure 1 at the beginning

of this article shows a typical testing scene in our Plate Supply Unit Department. The man at the left is testing work in process, the man on the right finished product. A detailed explanation of each man's apparatus and test methods will shortly be given.

Figure 4 shows, side by side, two Type 400 Power Amplifier and Plate Supply Units, one complete (except for cover) and the other complete except for the wax which seals the front compartments. A little study of this cut will make clearer some of the subsequent description. The reader will also please bear in mind in the discussion to follow that the Type 400 Unit is both a Power Amplifier and a Plate Supply Unit, using a 213 rectifier and a 171 amplifier tube, and that the Type 405 is a Plate Supply Unit only, using a Raytheon BH Rectifier Tube.



IET LABS, INC in the GenRad tradition

534 Main Street, Westbury, NY 11590

www.ietlabs.com

TEL: (516) 334-5959 • (800) 899-8438 • FAX: (516) 334-5988

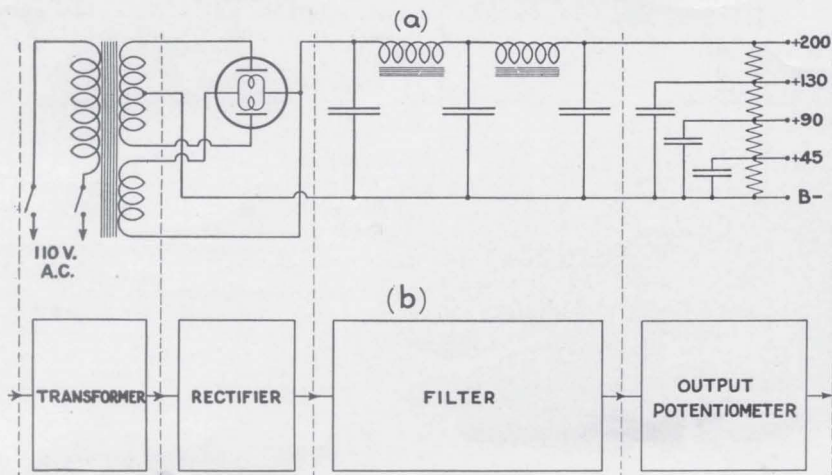

FIGURE 2

condensers at this point, as this is taken care of upon receipt of the condenser from the manufacturer, before the condensers are put in our stock of materials. The capacity is preferably checked not across the terminals of the condensers, but across the far ends of the wires leading from those terminals, thereby checking the wiring.

The showing of the correct resistance on the scale of the ohmmeter in checking the resistance between filter condensers both checks the wiring and shows that the chokes are not shorted or open. In a similar manner the choke of the speaker filter is tested in the Type 400.

A hot wire ammeter in series with the line, protected by a short-circuiting switch, is used to detect abnormal primary currents, caused by shorted turns in the transformer or short circuits of other kinds not

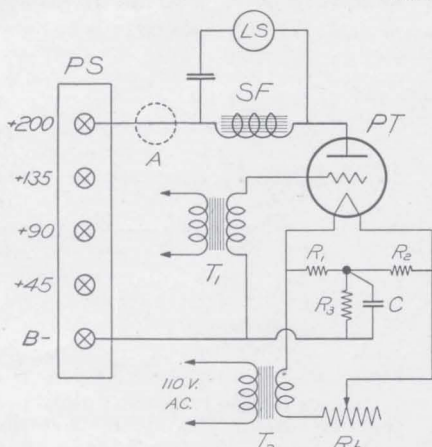

FIGURE 3

Figure 5 gives a better view of the apparatus used in testing partly completed units. It consists of

A.—Tube rectifier set for supplying high-voltage D. C. for testing condenser and transformer coil insulations.

B.—Transformer test box, containing switches for making various tests on transformers without altering connections of coil to test box.

C.—Box containing A. C. voltmeters used with transformer test box to measure high and low secondary voltages of transformers.

D.—Capacity meter, for measuring the capacity of each condenser in the unit.

E.—High-range ohmmeter for quick checking of large resistances.

F.—Low-range ohmmeter for quick checking of small resistances.

G.—Hum test board, holding circuit of 4MF condenser in series with headphones, for cutting out D.C. but listening to A. C. hum across output terminals. A short-circuiting switch is placed across the phones to protect the ears from the click due to charging current at the instant the circuit is closed.

H.—A D. C. voltmeter for measuring the output at the 45-volt tap.

J.—Two ammeters to be inserted in one side of supply line to test primary current. (Same as Item A, Figure 6, in description below).

U.—Unit under test. This equipment is made use of for the following tests with only the two front compartments, later to be waxed, now assembled.

With 110-volt A. C. supplied to the primary of the transformer (in the small compartment) the secondary voltages are checked, and then, with no A. C. input, insulation between separate windings and between windings and case (core) is tested by high D. C. voltage. Split secondaries must have the center taps in the center, giving the same voltage for each half of the coil. On the Type 400, the biasing resistance value is checked by an ohmmeter. On the Type 405, the small buffer condensers across the high-voltage secondaries are checked by the capacity meter.

By means of the capacity meter, each condenser in the unit is checked. No insulation test is given the con-

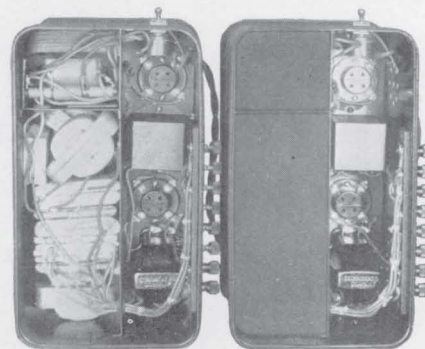

FIGURE 4

otherwise detected. This test also discloses the presence of insufficient or inferior iron in the core of the power transformer.

When these tests have been applied, the units are returned to the assemblers to have the assembly and wiring completed, after which the tubes are inserted, the unit connected to the 110-volt lines, the main switch turned off and on several

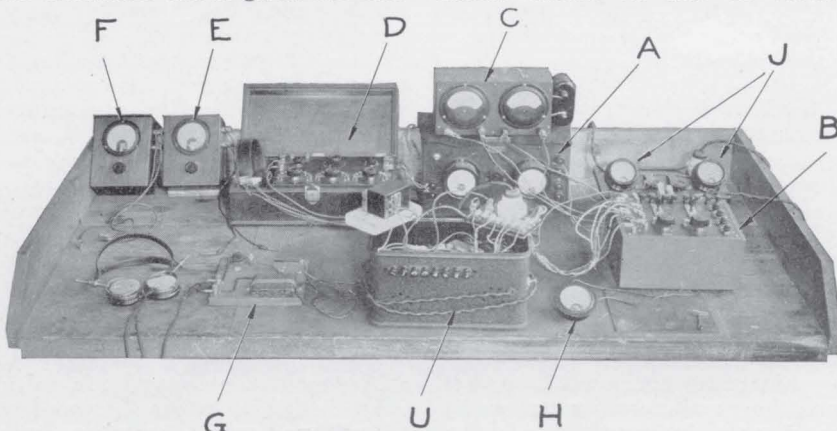

FIGURE 5

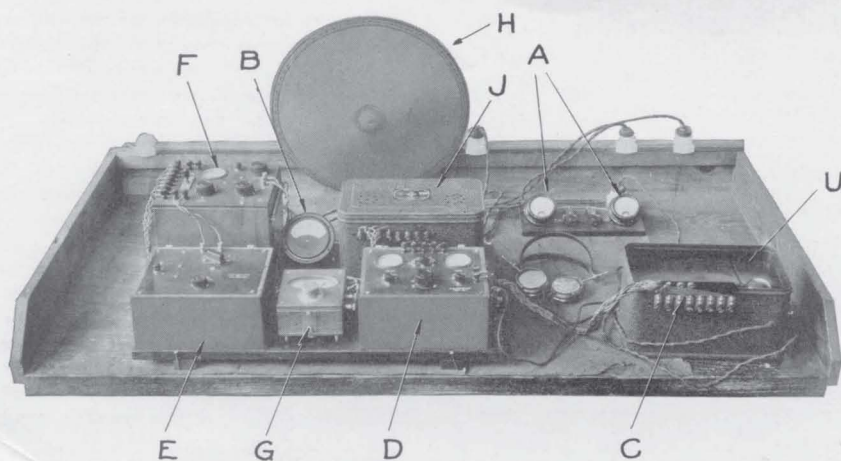

FIGURE 6

times to subject the condensers to the high momentary voltage surges encountered when the circuit is broken and the magnetic fields collapse rapidly, and these tests applied:

The voltmeter, placed across the plus 45 and B— terminal posts, should read a certain value if everything is correct. In the Type 400, the output terminals are shorted. If this lowers the voltmeter reading (except momentarily for charging current) it indicates a shorted condenser in the speaker filter.

The hum tester is placed across B— and each of the B plus voltages in turn. Abnormal amounts of hum, as learned by experience, indicate trouble. The hum tester is also applied across the speaker posts in the Type 400. While listening there, the input posts are short circuited. This should decrease the output hum considerably, since the grid is no longer floating after the transformer primary (input) has been shorted.

The value of the biasing resistance and the proper location of the center tap of the resistance unit across the amplifier filament secondary are checked by means of the ohmmeters.

A unit that has passed all of the above tests is ready to be poured with wax. After the wax has set and cooled, the unit is ready for final test using the apparatus shown in Figure 6:

A.—Series A. C. line ammeters, for showing primary current consumption. A high range meter is provided to protect the low range meter (large meter is always read first) and each is protected by a short-circuiting switch which is opened momentarily to take a reading.

B.—Line voltmeter to enable operator to decide whether voltage outputs are correct (see below, under D).

C.—Test clip, which slides quickly over binding posts and connects

unit under test to remaining apparatus.

D.—Box for measuring voltage under load. A multi-point switch connects any desired B plus tap across the load resistance, a 20,000 ohm wire-wound rheostat with an off position to enable measurement of voltage at no external load. A 25 M. A. meter in series with this rheostat measures the load. A shunt extends the range to 50 M.A. when desired. The voltmeter is a 1.5 M. A. meter in series with 100,000 ohms for 150-volt range, and with 200,000 ohms for 300-volt range. In the box is also a condenser-telephone circuit, similar to that of the hum test board (Fig. 4, G) which is connected at will across the terminals where the load is applied by closing a small switch in the circuit.

E.—Audio oscillator, for testing Type 400 Power Amplifier circuit. This is a vacuum tube oscillator, the tuned circuit of which consists of an iron-core inductance and a capacity made up of several paper condensers successively cut into the circuit by a switch. The oscillator produces five frequencies, ranging from a high to a low pitch.

F.—This case contains a vacuum tube voltmeter, indications of which are read from galvanometer or microammeter G. The vacuum tube voltmeter measures the amplitude of the audio output voltage, across loud speaker H, supplied from the audio amplifier of the Type 400 (D. C. component has been removed by speaker filter incorporated in Type 400 Unit). This is compared by means of the readings of G to the output from a standard Type 400 Power Amplifier, J, which is a permanent part of this test equipment. Aural comparisons of the two Type 400's are made simultaneously by listening to the output of the loud speaker H. Either test Unit U or

standard Unit J is introduced as the audio amplifier when a switch in this cabinet, F, is thrown one way or the other.

Finished Units undergo the following tests on the apparatus last described:

The primary current is checked on A, to see that it is not excessive. Each voltage tap is tested on D under three certain loads, and the voltages must come up to certain standards set by average performance of a great number of units. The switch introducing the phone circuit is closed and the hum observed on each tap under heavy load to see that it is not excessive.

For the Type 400, the load is removed, the phone circuit switch opened, and each audio frequency from E is in turn impressed first across U, then across J. For any frequency the microammeter readings will be very nearly alike for a correct Unit, although the readings from one frequency to another will vary, mainly because the oscillator delivers to the grid less energy at the low frequencies, and because of variation in the relative amounts of energy absorbed by the loud speaker at the different pitches. Listening to the loudspeaker with no input will check undue output hum. Shorting the input terminals should reduce this hum. A visual inspection follows to see that the unit is clean, that the switch Off-On plate and name plate are mounted correctly, and that the binding posts on the output panel are correct. After careful wrapping and packing in a carton, the unit is ready for shipment.

Encased parts intended for use in our Power Amplifier and Plate Supply Kits undergo similar tests which accomplish results the same as those obtained by the tests outlined above, except that, obviously, since the parts are not wired up together, no wiring external to the parts can be checked, nor can D. C. voltage output or audio output be checked.

Occasionally troubles will arise in service. Although condensers may break down, audio transformer windings open up, or other defects occur, it is quite certain that no unit leaves the factory defective or without test, since it is a rule that units do not reach the shipping room unless they have tags showing they have been tested. If, as is bound to happen, units become defective, it is fairly safe to say that such defects will have appeared only after some service.

Different defects show up differently in the behavior of the units. (See service table on next page.)



Service Table for Types 400 and 405 Units

The following table will cover most cases where failure of the Types 400 and 405 units to function properly is encountered. This table does not take completely into consideration defective tubes or conditions which lie beyond the units themselves.

EFFECT	CAUSE	
	TYPE 400	TYPE 405
NO B VOLTAGE	Open output resistance unit. Filter condenser shorted. Open filter choke. Rectifier tube defective.	Open output resistance unit. Buffer or filter condenser shorted. Open filter choke.
LOW B VOLTAGE	Speaker filter condenser shorted. Amplifier grid circuit open. Biasing condenser or resistance shorted. No bias on grid. One half of high-voltage secondary open. Defective ground from center of high-voltage secondary.	One buffer condenser shorted. One half of high-voltage secondary open. Defective ground from center of high-voltage secondary.
HIGH B VOLTAGE	Shorted filter choke. Amplifier plate circuit open (biasing resistance).	Shorted filter choke.
INCORRECT B VOLTAGES	by-pass condenser shorted. Output resistance unit shorted or open.	One mf. by-pass condenser shorted. Output resistance unit shorted or open.
OVERHEATING OF POWER TRANSFORMER	Excessive load drawn from output. Defective rectifier tube. Shorted filter condenser.	Excessive load drawn from output. Shorted filter condenser.
TOO MUCH HUM	Shorted filter choke. Open filter condenser. One side of amplifier filament center tap resistance open. Defective ground connection to common side of condensers.	Shorted filter choke. Open filter condenser. Defective ground connection to common side of condensers.
BUZZING NOISE FROM B SUPPLY (FREQUENCY VARIES WITH LOAD)		Defective Raytheon tube.
NO AUDIO OUTPUT	Defective audio transformer. Filter condenser shorted. Amplifier grid or plate circuit open. Defective amplifier tube.	
LOW DISTORTED AUDIO OUTPUT	Filter condenser shorted. Speaker filter condenser shorted. Grid circuit open on ground side of audio transformer (unilateral connection to grid). Biasing resistance shorted.	

film. Before starting, the needle is adjusted to a given index point on the record and a corresponding point is located on the beginning of the film. Hence, once started in step, a perfect synchronism between the picture and the Vitaphone is automatically maintained throughout the reel.

The needle running on the record drives a magnetophone pick-up device, consisting of an armature moving in the field of an electromagnet, whereby the vibrations which the needle receives from the record are reproduced electrically. The corresponding current impulses are then

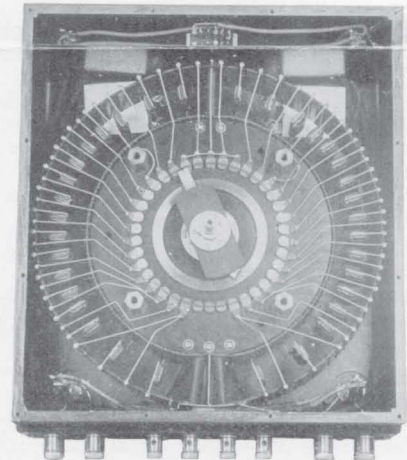

passed into a series of power amplifiers, similar in general principle to the public address systems, where they become greatly magnified before entering a series of large loud-speaker horns concealed in the orchestra pit, and also above the screen. The reproduction is exceedingly realistic and the whole art of offers wide possibilities.

The Fader consists of a series of adjustable resistances or attenuation networks, as they are called, through which the electrical currents from the magnetophone must pass before entering the amplifiers. The object of the Fader is to afford a means whereby a change from one record to another may be made in such a manner as to be quite imperceptible to the audience. It serves, likewise, as a control device whereby changes in the intensity of the reproduced sound may be made as occasion requires.

On the illustration showing the front view of the Fader will be seen the hand wheel for adjusting the attenuation networks, together with the scale for indicating the relative intensity. An interior view showing the networks mounted on the control switch is given in the other illustration.

The Vitaphone Fader

A Device Manufactured by the General Radio Co. for Use in Conjunction with Vitaphone Motion Picture Reproduction

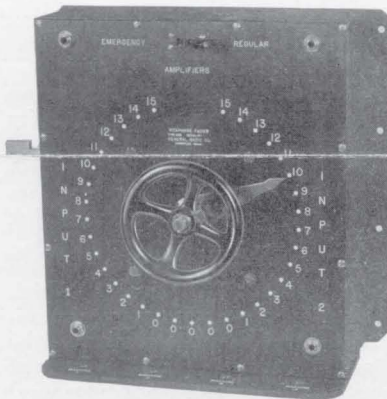

In addition to the continuous improvement of radio parts and accessories the engineering staff of the General Radio Company has frequent occasion to design and develop a wide variety of electrical instruments, both for research work and for commercial use. A recent example of their efforts along these lines is an instrument known as the Fader, which is shown in the illustrations and which forms a part of the equipment of the Vitaphone.

The Vitaphone is a new process recently perfected by the Bell Telephone Laboratories, in conjunction with the Warner Brothers Motion Picture Producers, for the electrical reproduction of speech and music as an accompaniment to motion pic-

tures. The method may be briefly described as follows:

A large and especially fine talking machine record is made, say, of orchestration to accompany a picture. This record, which turns much more slowly than the records of the ordinary talking machine, is made large enough to play throughout a standard motion picture reel. It is placed upon a rotating table which is driven by the same motor that drives the

Printed in U.S.A.

